

PLANMECA

2D imaging



Welcome

An introduction from our President

Industry-leading 2D X-ray units	4
A new benchmark for extraoral imaging	6
Planmeca ProMax® 2D	8
Perfect panoramic images – every time.....	10
Effortless and comfortable.....	12
Robotic arm technology.....	14
All the imaging programs you need	16
Extraoral bitewings	18
New opportunities for tomography	20
Quality cephalometry for orthodontics	22
Easy upgrade from 2D to 3D.....	24
Planmeca ProOne®	26
Optimal imaging programs	28
Intraoral imaging	30
Planmeca ProX™	32
Planmeca ProSensor®	34
Planmeca ProScanner™	36
Planmeca Romexis® software for all images	38
High-performance 2D imaging.....	40
Your mobile world of imaging.....	42
Share images and expertise online.....	44
Technical specifications	46



“It’s my great pleasure to introduce you to our pioneering 2D X-ray units. Our comprehensive range of digital units meets all your daily imaging needs – working perfectly with our highly advanced **Planmeca Romexis®** software for the most detailed extraoral and intraoral examinations possible.

I’m extremely proud of our product innovations, and for over 40 years we’ve worked closely with dental professionals to set new standards in our field. What makes us a bit different is that all core product development and manufacturing takes place in Finland – ensuring exceptional quality and unmatched attention to detail at every stage of the process.

And we also have a dedicated team of R&D professionals behind the scenes, developing breakthrough innovations that make a real difference. Our robotic SCARA technology, for example, offers flexible, precise and complex movements needed for extraoral maxillofacial imaging. Our **Planmeca ProMax® 2D** X-ray units are all 3D-ready, which means you can easily upgrade at a later point. Therefore I’m thrilled to invite you to discover our world of 2D imaging.”

*Heikki Kyösti
President and founder
Planmeca Group*

Industry-leading 2D X-ray units

Mac OS
and Windows
compatible

*Introducing our world-class range of 2D X-ray units
– offering the most advanced and versatile devices and software
to meet all your 2D extraoral and intraoral imaging needs.*



Planmeca ProOne®



Planmeca ProX™

Planmeca ProSensor®



Planmeca ProScanner™

Planmeca ProMax® 2D

A new benchmark for extraoral imaging

*Planmeca extraoral units offer two alternative solutions to maxillofacial imaging. **Planmeca ProMax**® – the complete imaging centre – sets a new benchmark in panoramic and cephalometric imaging. **Planmeca ProOne**® is designed with simplicity in mind. It is a compact and easy-to-use panoramic X-ray unit that's both cost-effective and flexible.*



Planmeca ProMax[®] 2D



Planmeca ProMax[®] is a complete maxillofacial imaging system. The design and operation principles are based on the latest scientific research, technological innovations and the most demanding needs of modern-day radiology.

Key features:

Advanced technology

- **Autofocus** positions the focal layer automatically for perfect panoramic images
- **Dynamic Exposure Control (DEC)** measures the patient's radiation transparency and automatically adjusts exposure values
- Patented **SCARA** (Selectively Compliant Articulated Robot Arm) technology guarantees an anatomically correct imaging geometry for clear, error-free images
- Easy upgrades – add cephalostat or 3D imaging capability at any time

Effortless use

- Full-view patient positioning with triple-laser patient positioning lights
- Side entry for comfortable access
- Easy-to-use graphical interface
- Versatile **Planmeca Romexis[®]** 2D imaging software
- TWAIN support and full DICOM compliance

Perfect panoramic images – every time

Imagine if your X-ray unit could recognise your patient's anatomy

The unique **Autofocus** feature automatically positions the focal layer using a low-dose scout image of the patient's central incisors. It uses landmarks in the patient's anatomy to calculate placement, enabling practically error-free patient positioning and dramatically reducing the need for retakes. The result is a perfect panoramic image.

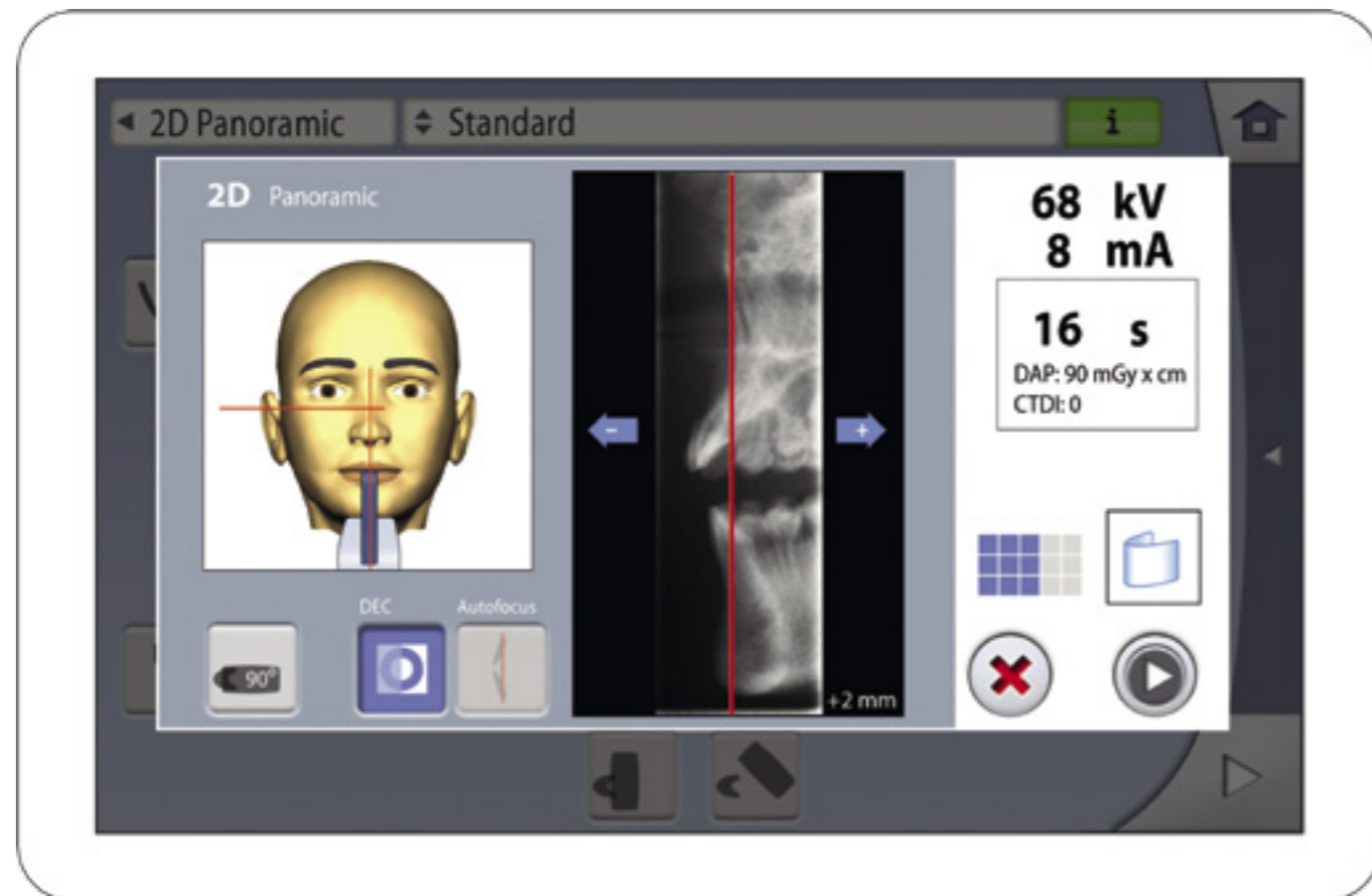

Our unique Autofocus

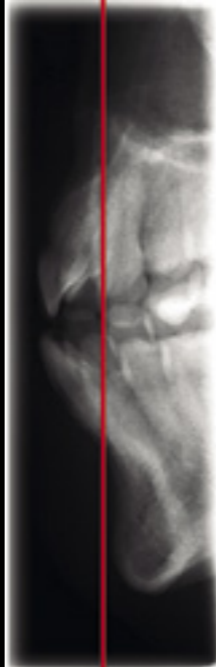

Positioning errors are now a thing of the past – with SCARA technology you can take an ultra-low-dose scout image of your patient's central incisors for a fast diagnostic panoramic image every time.

Effortless and comfortable

Our industry-leading **Planmeca ProMax®** unit is known across the world for incredible ease of use and exceptional patient comfort. A relaxed patient means a smooth imaging workflow and the best possible image quality.

Open patient positioning

- Position patients effortlessly thanks to open-face architecture
- Correct patient positioning either with Autofocus or manually
- Make fine adjustments using positioning lasers and joystick
- Work with an unrestricted view of your patient
- Avoid claustrophobic feelings in patients
- Accommodate wheelchairs easily with side-entry access

User-friendly control panel

- Clear and straightforward graphical user interface guides you smoothly through your work
- Pre-programmed sites and exposure values for different image types and targets save you time and allow you to focus on your patients

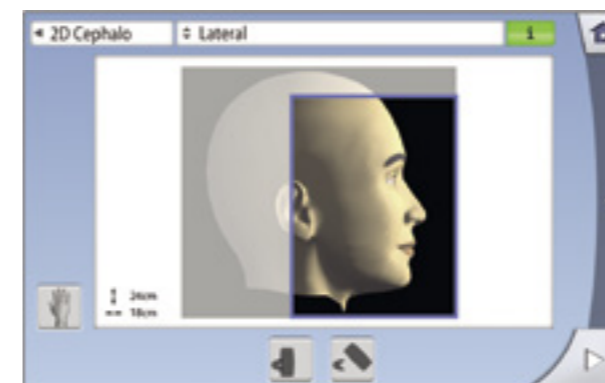
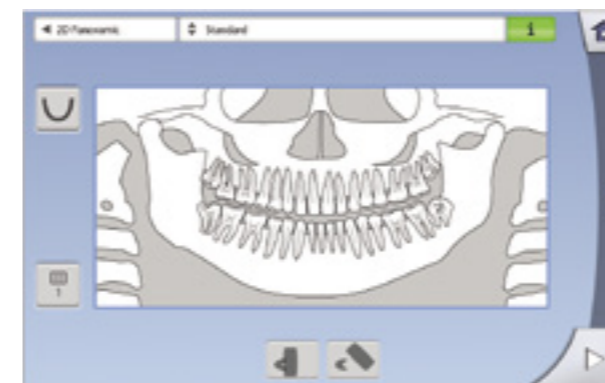
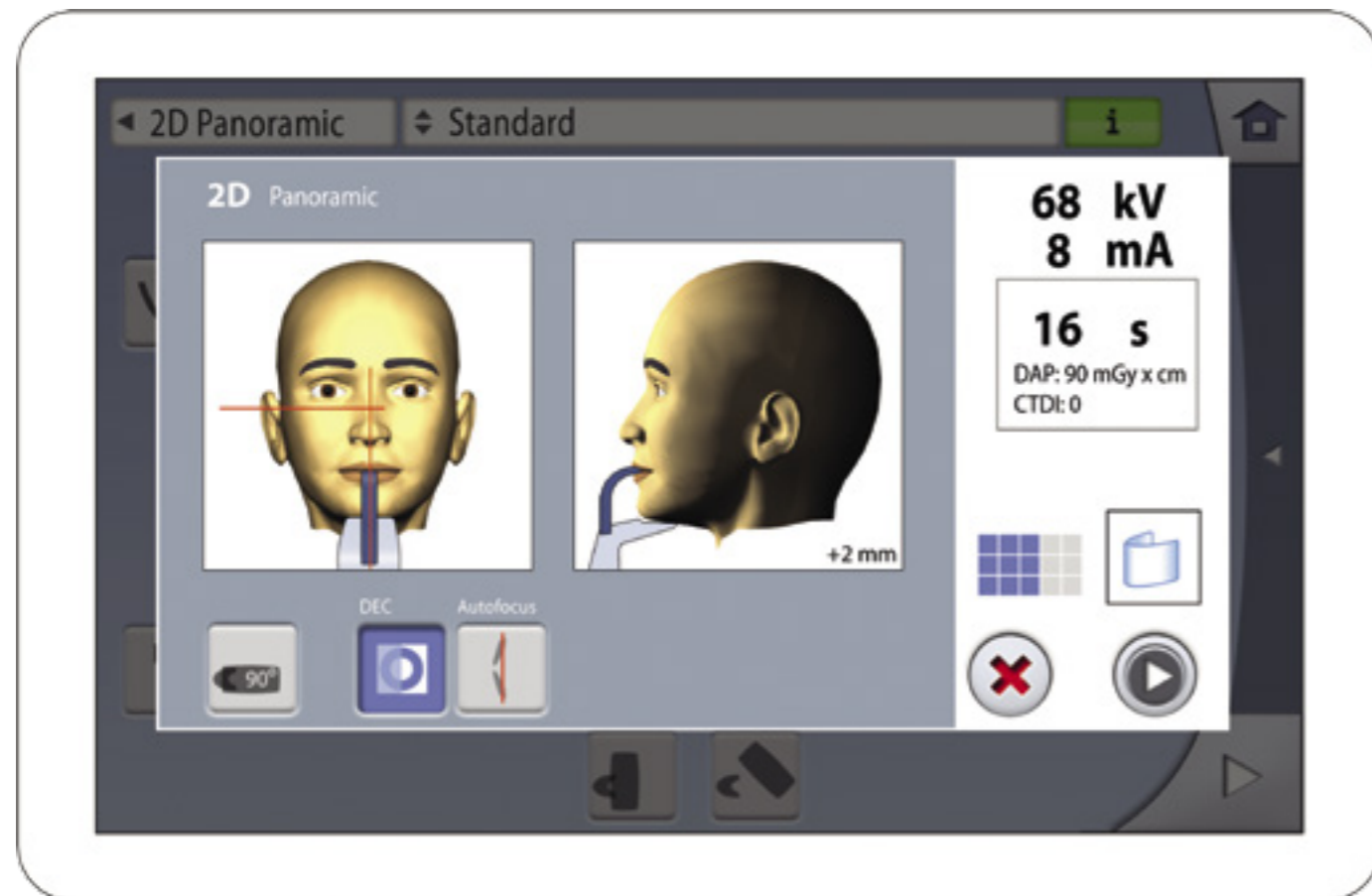

Laser-assisted patient alignment

- A triple laser beam system accurately indicates the correct anatomical alignment points for patient positioning
- The midsagittal plane positioning beam indicates the correct sideways alignment
- The Frankfort horizontal plane positioning beam shows the correct forward tilt of your patient's head
- The focal layer positioning beam indicates the focal layer position and ensures images are sharp and clear
- Fine adjustments can be made using the joystick

Improved image quality with Dynamic Exposure Control (DEC)

The unique digital Dynamic Exposure Control (DEC) automatically adjusts the exposure values for each individual patient based on their anatomic structure and bone density. DEC improves the quality of both panoramic and cephalometric imaging with more consistent brightness and contrast.

Adjustable focal layer

Developed based on scientific research, the imaging geometry matches the shape of the focal layer with the patient's anatomy, resulting in clear panoramic radiographs. Simply select the shape of the focal layer on the graphical user interface, according to the size and shape of the patient's jaw.



Robotic arm technology

Planmeca ProMax® features highly advanced and exclusive robotic SCARA (Selectively Compliant Articulated Robot Arm) technology – providing flexible, precise and complex movements required for rotational maxillofacial imaging.

Unlimited movement range

Our revolutionary SCARA technology combines an electro-mechanical construction with real-time computation of dynamic rotation patterns. This enables optimised radiography for each individual patient, meeting virtually any diagnostic requirement for maxillofacial dentistry.

User benefits for SCARA

The precise free-flowing arm movements allow for a wider variety of imaging programs not possible with other X-ray units with fixed rotations. SCARA offers superior imaging capabilities for both existing and future technologies.



Different models for different needs

Planmeca ProMax® 2D S3

The three-joint model (SCARA3) **Planmeca ProMax® 2D S3** has been designed for all imaging needs: panoramic, true extraoral bitewing, TMJ, sinus and 2D tomography.

Planmeca ProMax® 2D S2

The two-joint model (SCARA2) **Planmeca ProMax® 2D S2** includes basic programs for panoramic, extraoral bitewing, TMJ and sinus imaging.

Both models can be easily upgraded to 3D imaging.

Imaging programs

	Planmeca ProMax 2D S3	Planmeca ProMax 2D S2
<i>Standard:</i> Basic panoramic programs	Standard panoramic Lateral TMJ (closed & open) PA TMJ (closed & open) PA sinus	Standard panoramic Lateral TMJ (closed & open) PA TMJ (closed & open) PA sinus
<i>Standard</i>	Child (Paediatric) mode for each standard and optional program to reduce the dose	
<i>Optional</i>	Horizontal and vertical segmenting for panoramic program	Horizontal and vertical segmenting for panoramic program
<i>Optional</i>	True Bitewing	Bitewing
<i>Optional:</i> Advanced panoramic programs	Interproximal panoramic Orthogonal (perio) panoramic Lateral-PA TMJ Lateral multiangle TMJ PA multiangle TMJ PA linear sinus Lateral sinus	
<i>Optional:</i> Tomography programs	Digital linear tomography and Transtomography in digital unit True linear tomography or Linear tomography in film unit	

All the imaging programs *you need*

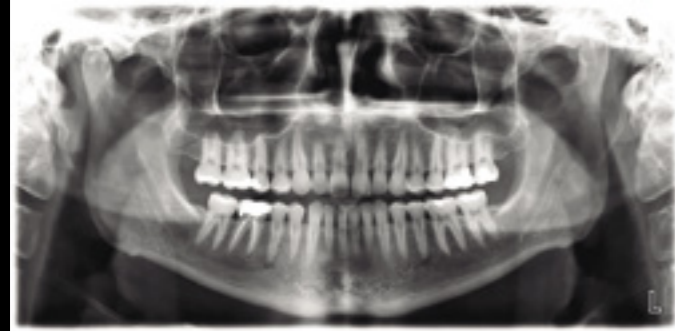

Standard Panoramic



Horizontal and vertical segmenting

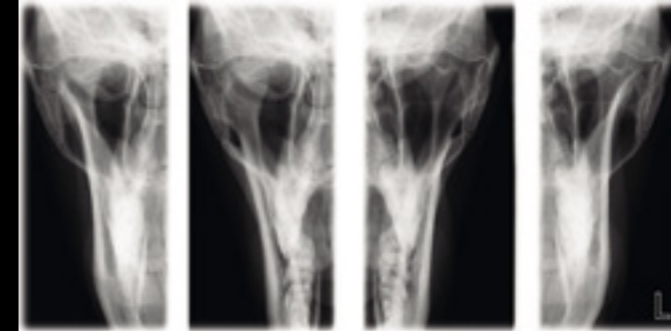

PA TMJ (closed & open)

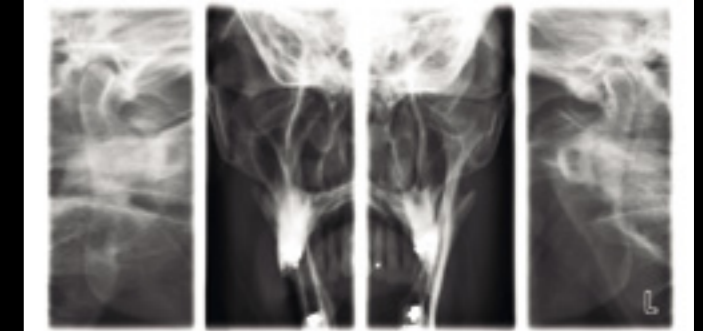

Lateral-PA TMJ

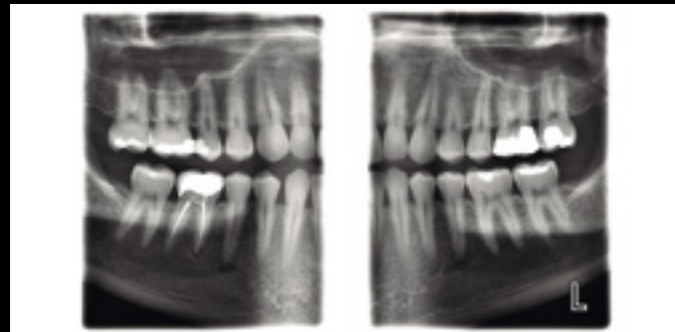

True Bitewing



Horizontal and vertical segmenting

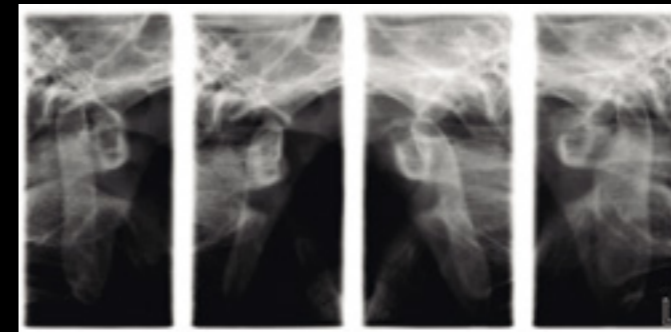

Lateral TMJ (closed & open)

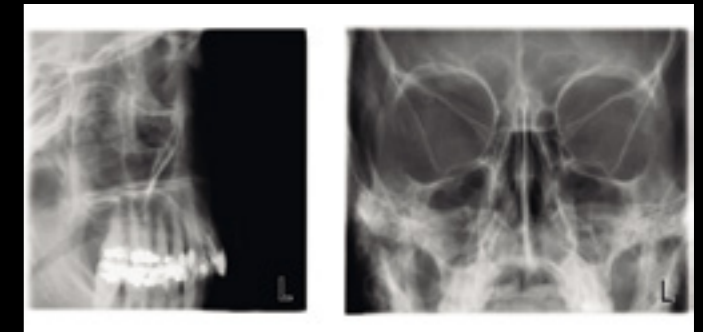

Lateral sinus and PA linear sinus

Our **Planmeca ProMax®** X-ray unit offers the widest variety of imaging programs available – easily meeting all your clinical needs.

Panoramic imaging

In addition to the Standard panoramic program, the following programs are offered:

- Interproximal panoramic program: generates an image, where interproximal teeth contacts are open. Primarily used for caries detection.
- Orthogonal panoramic program: produces an image with clearly visible alveolar crest for improved diagnostics. Ideal for periodontal imaging and implant planning.

Extraoral bitewings

The Bitewing program uses improved interproximal angulation geometry. The result is a bitewing image pair with low patient dose and excellent diagnostic quality.

Horizontal and vertical segmenting for panoramic program

With the Horizontal and vertical segmenting program, exposure can be strictly limited to the diagnostic region of interest. Patient dosage is reduced by up to 90% compared to full panoramic exposure.

TMJ imaging

The TMJ imaging programs produce lateral or posteroanterior views of open or closed temporomandibular joints. The imaging angle and position can be adjusted to correspond to the anatomy of each individual patient.

The Lateral-PA TMJ program captures lateral and PA views on the same radiograph. The multi-angle TMJ programs produce radiographs with images from three different angles, from either the lateral or PA view.

Sinus imaging

The Sinus programs provide a clear view of the maxillary sinuses.



Child mode for reduced dose

Child mode reduces the patient dose remarkably for all programs by reducing the imaging area and exposure values. In the panoramic program the focal layer can also be narrowed.

Extraoral bitewings

What if you could do all your routine diagnostic imaging extraorally?

Planmeca ProMax® extraoral bitewings are ideal for periodontics, elderly and child patients, claustrophobic patients, patients with a strong gag reflex, and patients in pain. Extraoral bitewings enhance clinical efficiency and take less time and effort than conventional intraoral bitewing imaging.



What are the advantages of extraoral bitewings?

- Ideal for all patients – no sensor positioning required
- Consistently opens interproximal contacts, giving better diagnostic value
- Larger diagnostic area than in intraoral modalities
- More clinical data: canine to third molar
- Enhanced clinical efficiency – takes less time and effort than conventional intraoral bitewings
- Enhanced patient experience and comfort – eliminates gagging

Better diagnostic value with extraoral bitewings

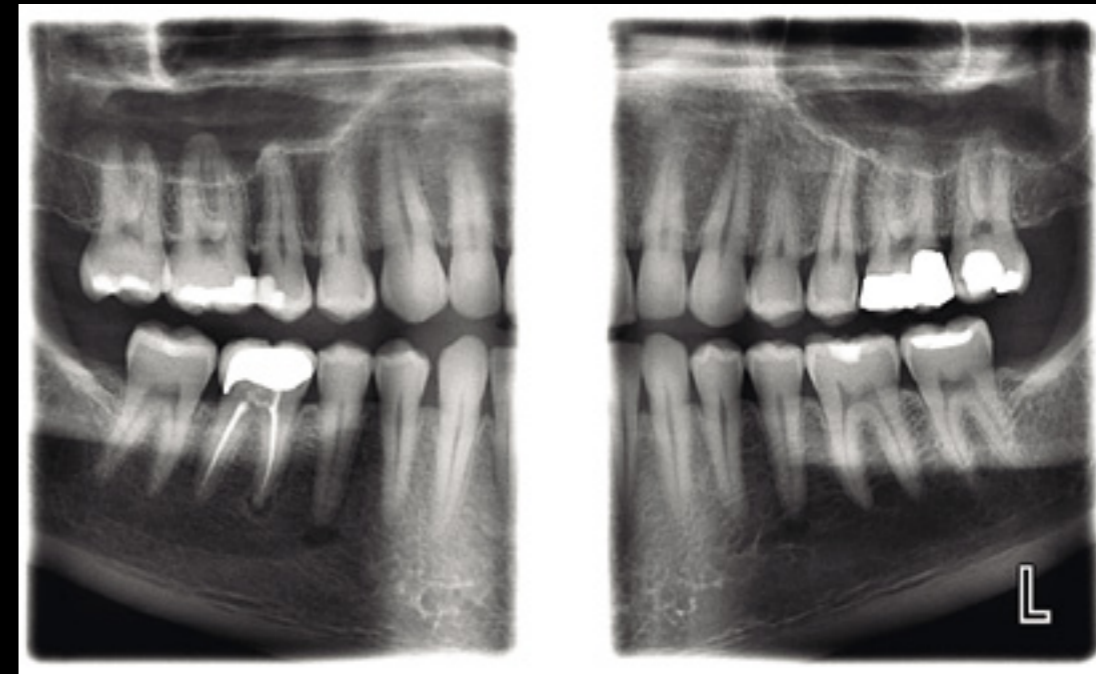

True Bitewing program, adult



Standard panoramic image of the same patient as the bitewing above

True bitewings only possible with our SCARA3 technology

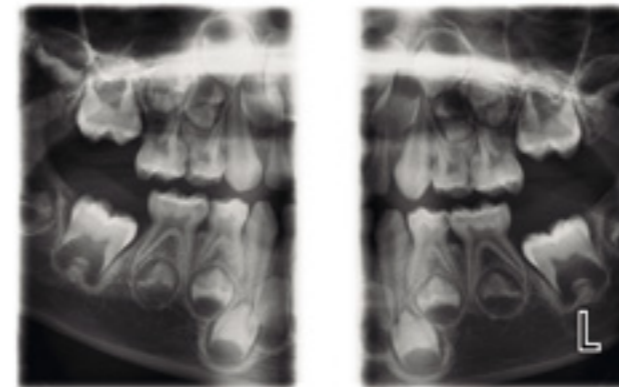

True Bitewing program, 5-year-old child

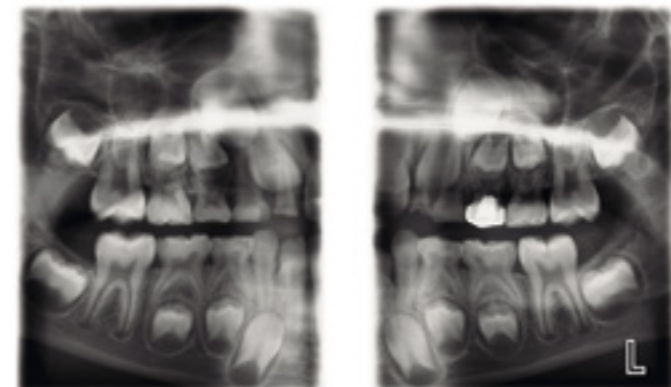

True Bitewing program, 8-year-old child



New opportunities for tomography

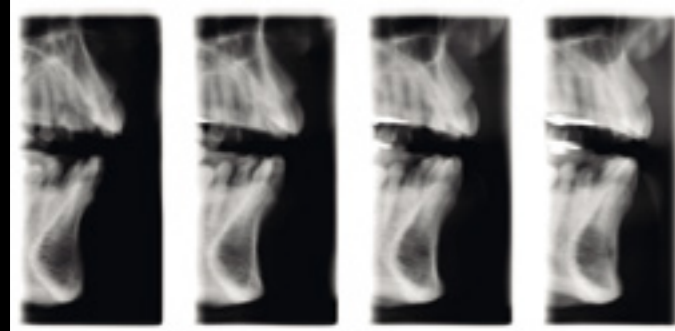

Cross-sectional tomography

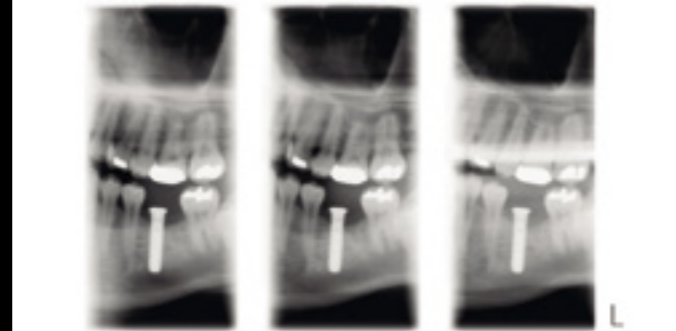

Longitudinal tomography

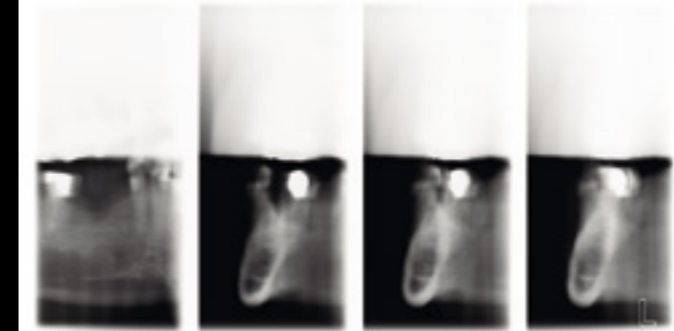

Combined tomography

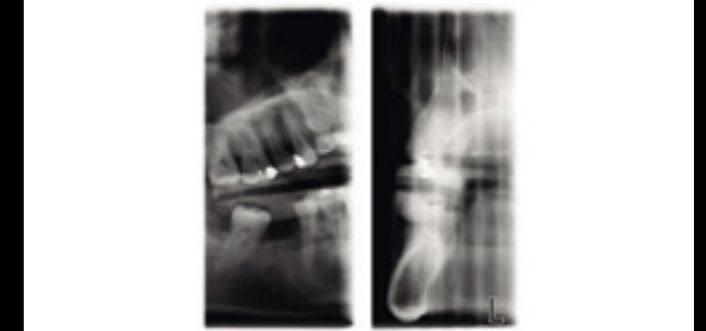

Combined tomography

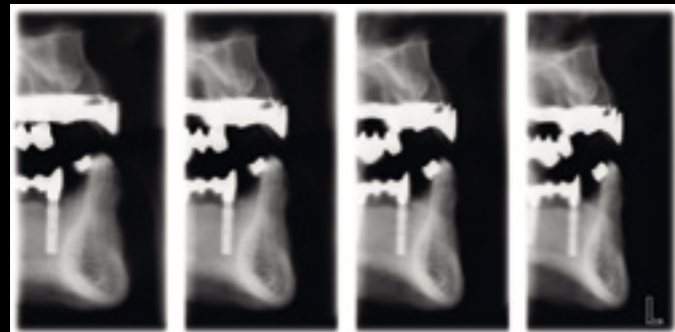

Cross-sectional tomography

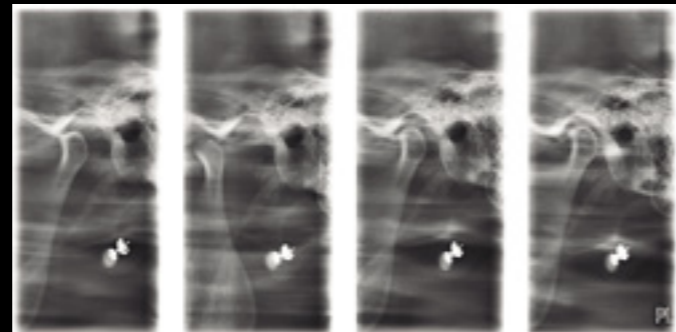

Longitudinal tomography



Combined tomography

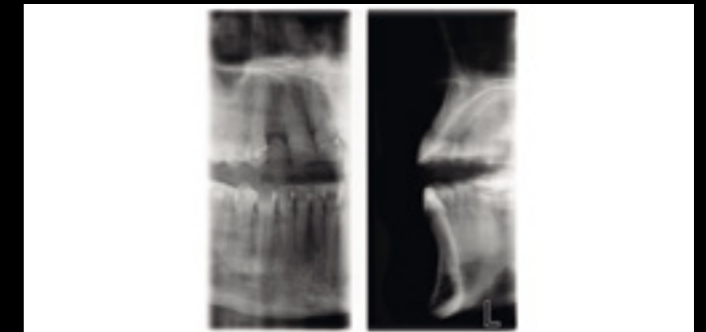

Combined tomography

Planmeca ProMax® 2D tomography programs provide accurate tomographic information for the analysis, planning and follow-up of implant and surgical procedures.

Valuable tool for implantology

The **Planmeca ProMax®** tomography system produces clear tomographic slices of any part of the maxilla, mandible, or temporomandibular joints. The cross-sectional or longitudinal tomographs can be adjusted to any specific angle, and the constant 1.5x magnification factor and combination programs enable accurate measurements.

Accurate automated tomography

The position and angle of the tomographic exposure is automatically pre-adjusted according to program and target selection. An impression model of the patient's dental arch can be used for easy and reliable fine-alignment, which can then be carried out practically and intuitively using the positioning joystick. The dual laser beams indicate the exact site and orientation of the tomographic cut.

Ingenious Transtomography®

The digital tomography option in Planmeca ProMax offers two imaging systems: digital linear tomography and **Transtomography®**.

Our ingenious patented Transtomography system allows easier patient positioning and enhances the diagnostic value of the image. It uses a multiple-swing method to produce a linear tomography effect with a narrow X-ray beam.

Combined, cross-sectional and longitudinal tomography

The tomography programs include a wide range of manual and automatic cross-sectional and longitudinal imaging programs and their combinations.

Combined tomography is highly valuable in implant planning, integrating cross-sectional and longitudinal views on the same radiograph. Both transversal and longitudinal views show the same position in two perpendicular projections, giving three-dimensional information on the target with the same magnification.

Quality cephalometry for orthodontics

We offer exceptional equipment and the most advanced software for all your orthodontic needs.



Two available options:

One-shot Planmeca ProCeph™ cephalostat

- Effective one-shot cephalostat
- Short exposure time – no motion artefacts, low patient dose
- Image sizes from 18 x 25 cm to 30 x 25 cm

Scanning Planmeca ProMax® cephalostat

- Digital cephalostat that scans your patient's head horizontally using a narrow X-ray beam with an extremely low effective dose of radiation
- Exceptional flexibility in image formats, with field sizes of up to 30 x 27 cm

Cephalometric imaging with Planmeca ProMax® units

- The functional and easy-to-use head positioner ensures accurate positioning for all cephalometric projections
- The carbon fibre ear posts and nasal positioner are extremely stable, hygienic, and transparent to radiation
- The unit automatically aligns itself to take cephalometric exposures and then selects a corresponding collimator

Easier and more accurate than ever before

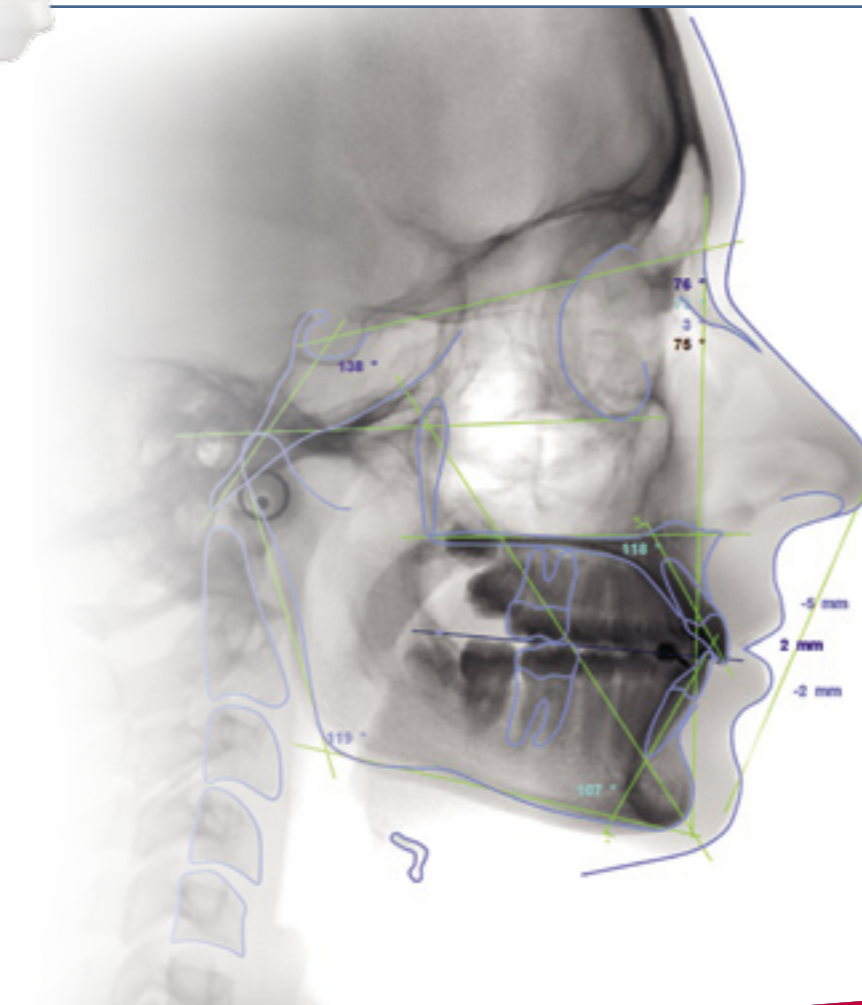

Planmeca Romexis® Cephalometric Analysis module

- Create cephalometric analyses and superimpositions in minutes
- Fully customisable analyses, norms and reports
- Microsoft Excel export and import function
- Compatible with Windows operating system

Easy upgrade from 2D to 3D



Planmeca ProMax® – future proof and a great investment

Planmeca ProMax® 2D is designed with upgradeability in mind. The unit's modular structure allows easy conversion to different imaging modalities, while the software-driven SCARA is extremely flexible, allowing you to benefit from new imaging projections.

Whether you're upgrading your 2D unit to 3D, or adding a cephalometric arm, Planmeca has the right solution for you.

Individual options can be installed before delivery or added later, making Planmeca ProMax the most versatile all-in-one X-ray unit available.

2D unit
Planmeca ProMax 2D S3

3D unit
Planmeca ProMax 3D s

3D unit
Planmeca ProMax 3D Classic

2D unit
Planmeca ProMax 2D S2

2D unit
Planmeca ProMax 2D S3

3D unit
Planmeca ProMax 3D s

3D unit
Planmeca ProMax 3D Classic

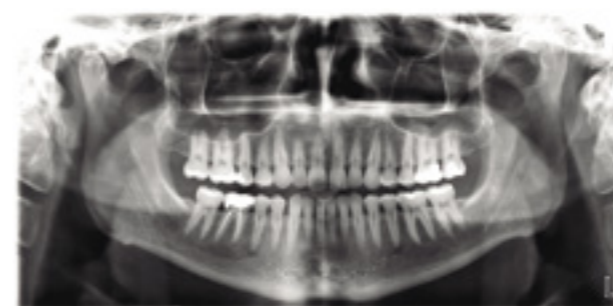

Planmeca ProOne®



Planmeca ProOne® is our full-featured panoramic X-ray unit, designed with simplicity in mind. Featuring cutting-edge innovations, Planmeca ProOne combines extensive diagnostic capabilities and superior image quality into a compact, easy-to-use package.

Easy patient positioning

Open patient positioning and side entry minimise errors caused by incorrect patient positioning by allowing you to monitor the patient freely from both the front and side. Side entry allows easy access for all patients – standing or seated. Patient positioning is assisted by our triple laser beam system, which indicates the correct anatomical positioning points.

User interface provides guidance

The full-colour graphical user interface provides clear texts and symbols to guide you through your procedure. Settings are logically grouped and easy to understand, speeding up imaging and allowing you to focus on positioning your patient correctly and communicating with them.

Autofocus – for perfect panoramics every time

The unique **Autofocus** feature automatically positions the focal layer using a low-dose scout image of the patient's central incisors. Landmarks in the patient's anatomy are used to calculate placement, enabling practically error-free patient positioning and dramatically reducing the need for retakes. The result is the perfect panoramic image, every time.

Optimal imaging programs



Standard panoramic

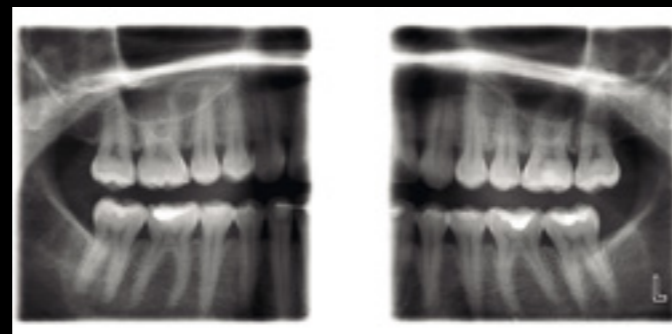

Bitewing

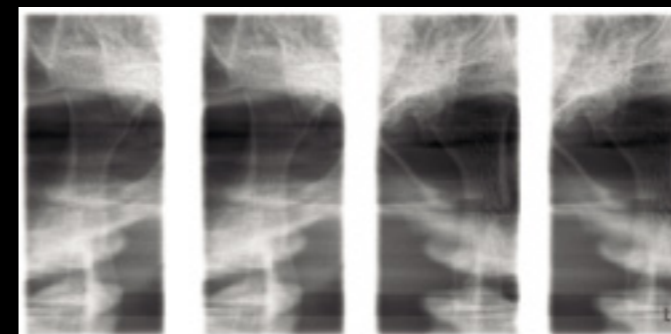

PA TMJ

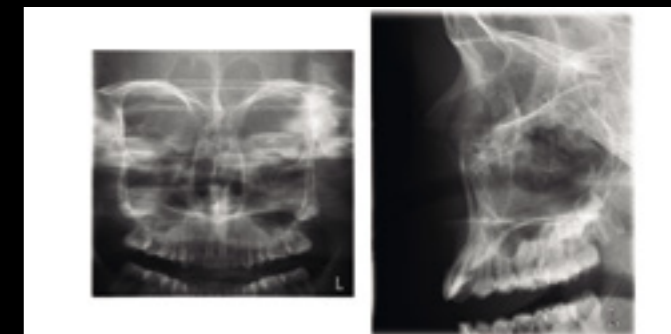

PA Sinus and Lateral non rotational sinus

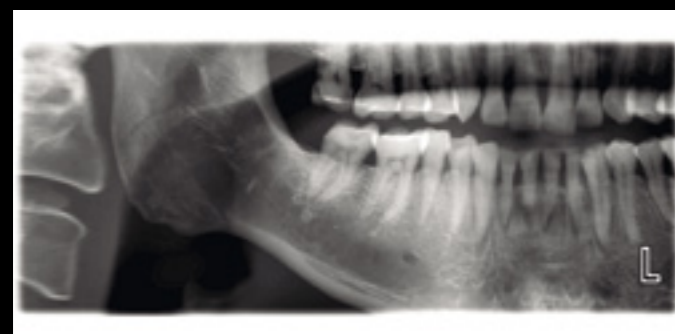

Horizontal and vertical segmenting for panoramic program



Lateral TMJ

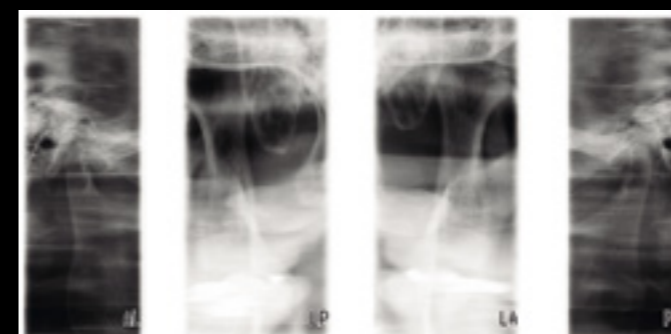

Lateral-PA TMJ



Cross-sections

Planmeca ProOne® offers you a wide variety of imaging programs for different radiographic needs. You can also select the correct exposure formats to minimise the radiation dose for all types of patients and diagnostic purposes.

Imaging programs

Basic panoramic programs	Standard panoramic
	Lateral TMJ
	PA TMJ
	PA Sinus
	Horizontal and vertical segmenting for panoramic program
	Bitewing
Advanced panoramic programs	Interproximal panoramic
	Orthogonal (perio) panoramic
	Lateral-PA TMJ
	Lateral multiangle TMJ
	Lateral non rotational sinus
	Cross-sections
	Child (Paediatric) mode for each program to reduce the dose



Child mode for optimal paediatric imaging

In child mode, the imaging area and exposure values are reduced in all programs and also the focal layer can be narrowed in the panoramic program. The patient dose is reduced remarkably.

Intraoral imaging

Our premium **Planmeca ProX™** intraoral X-ray unit and advanced sensor system **Planmeca ProSensor®** combine perfectly to meet your intraoral imaging needs. The integrated system guarantees a smooth imaging workflow, while the smart design features make it effortless to use. Our full-featured **Planmeca ProScanner™** imaging plate scanner offers top-quality images and a fast scanning process to support your everyday tasks.

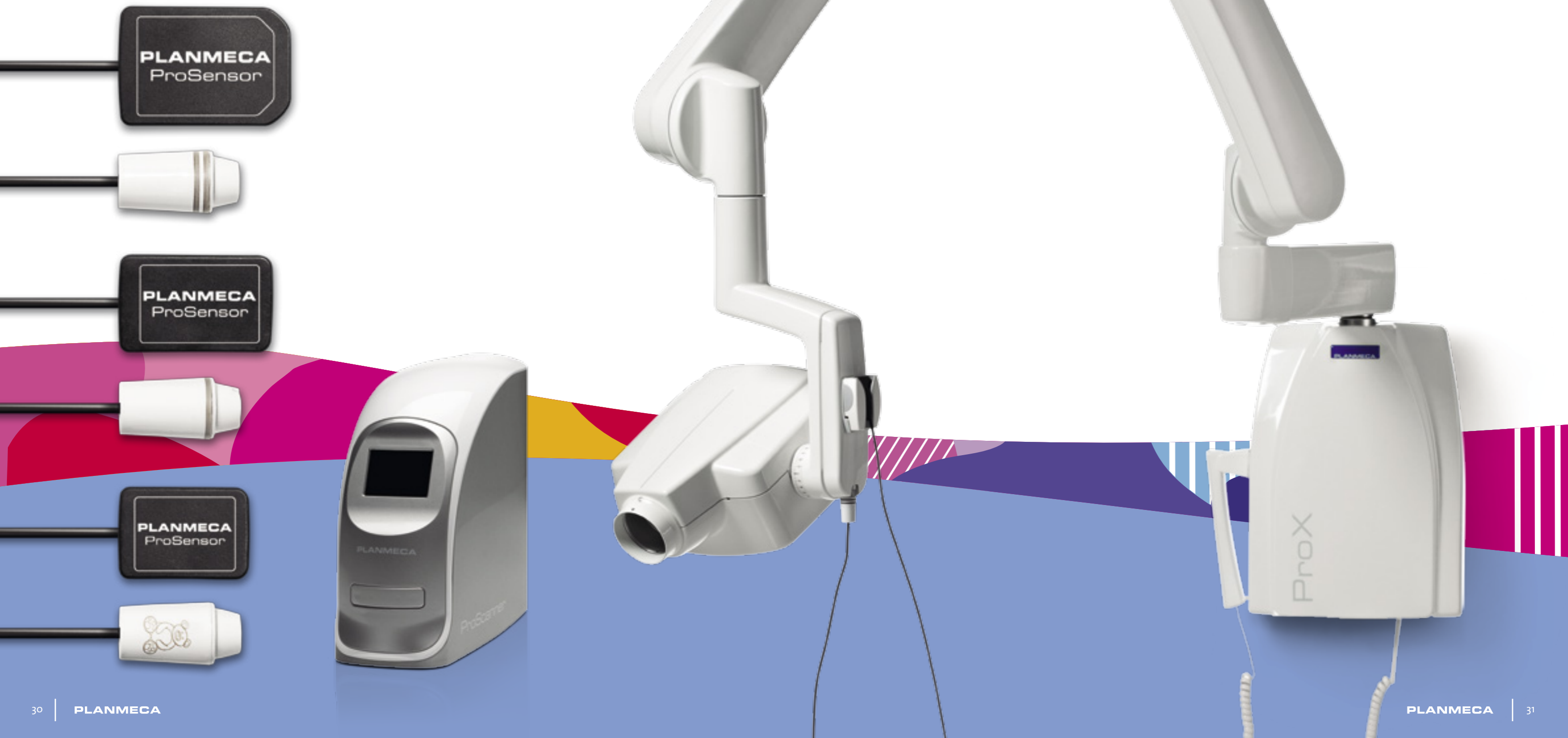

Planmeca ProX™

We're very proud to introduce **Planmeca ProX™** – the latest intraoral X-ray unit to feature in our exceptional range of imaging products. This advanced unit provides easy and precise positioning, a straightforward imaging process and top quality images in high resolution. Planmeca ProX is uniquely designed to make intraoral imaging easier and more reliable than ever.

The premium intraoral X-ray unit

- Optimal images for all diagnostic needs: variable kV and mA
- Quick and easy to use: pre-programmed quick settings, practical design
- Digital-ready
- Integrated with **Planmeca ProSensor®** system
- Smooth workflow with **Planmeca Romexis®**
- Versatile installation options

Highly adaptable imaging

Planmeca ProX™ adapts to both short-cone and long-cone imaging techniques. For maximum radiation hygiene, an additional rectangular collimator can be adapted for the long cone.

The steady X-ray unit arm provides accurate and drift-free positioning of the lightweight tube head. The unit's flexible installation options mean it can accommodate a wide range of requirements and clinic layouts.

Quick imaging parameter settings

Planmeca ProX comes pre-programmed with quick settings for different exposure value combinations. Imaging parameters are automatically retrieved according to the selected exposure region and the diagnostic need, and values can also be manually adjusted if necessary. Simply select the image receptor to automatically adapt the pre-programmed settings for film, imaging plate or digital sensors, allowing rapid transition to new imaging technologies without reprogramming.

Faster X-ray examinations with digital sensor

Benefit from the ultimate in user-friendly intraoral imaging by combining Planmeca ProX with the Planmeca ProSensor digital sensor system. The image is displayed on the screen just seconds after exposure, significantly reducing the time needed for an intraoral X-ray examination compared to conventional film.



Planmeca ProSensor®

Our **Planmeca ProSensor®** intraoral sensor uniquely combines patient-centric design with usability and durability. We guarantee a smooth workflow, excellent image quality and patient safety in all treatment situations.

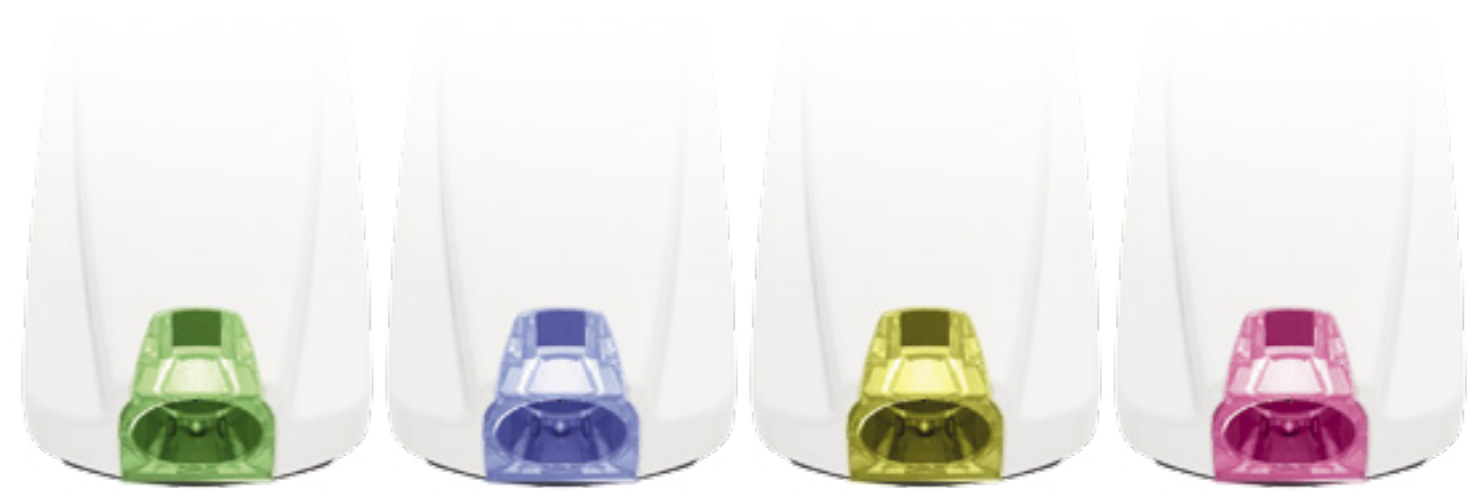

Clever design details

All three sensor sizes (0, 1 and 2) are marked with a clear symbol on the magnetic connector for easy use. The rounded corners on size-2 sensors significantly improve patient comfort. The sensor cable is strengthened with Kevlar and consists of only two wires – its extreme durability has been proven in comprehensive testing. This hermetically sealed sensor can be fully immersed in disinfectant for effective infection control.

Robust sensor

The intelligent sensor housing design, with its rounded edges and extensive active imaging area, maximises both patient comfort and imaging performance.

Magnetic connector

With its three sensor sizes, **Planmeca ProSensor®** makes no compromises when it comes to usability. The magnetic connector between the sensor and the control box ensures the sensor is always correctly inserted, with easy connection and convenient one-handed operation.

Moreover, it also enhances safety – if the X-ray source or patient moves drastically, the connection is instantly interrupted.

High-quality images – without compromise

The LED light and the different colour-coded control box lights indicate the state of the sensor system, guiding you and ensuring a successful image. Planmeca ProSensor is available with either a USB or an Ethernet interface. The TrollByte Plus sensor holder is designed for full-mouth surveys and guarantees high quality images even in hard-to-reach areas, without compromising patient comfort.



Planmeca ProScanner™

Full-featured imaging plate scanner

Our comprehensive intraoral imaging family is now complemented by a compact and intelligent imaging plate scanner. **Planmeca ProScanner™** offers a fast scanning process and smart design details to support your everyday tasks. It is a powerful solution for both chairside and shared multi-room use.

Compact and fast

The small and compact **Planmeca ProScanner™** with streamlined and elegant design fits any room. Top-quality images are acquired in just a few seconds.

Easy and intelligent use

Scanning is made easy with a magnetized 'push and go' feeding tray that is inserted for scanning with a simple push. Imaging plates snap to the feeding tray easily thanks to their corresponding magnets. The embedded eraser prepares the plates for immediate reuse. After each scan, a preview image is displayed on the scanner's LCD touch screen for instant verification of the result.

Smart imaging plates in all sizes

Planmeca ProScanner supports all imaging plate sizes – 0, 1, 2, 3, and 4c. The extra thin plates are comfortable for the patient, and are equipped with an RFID chip holding an electronic serial number. You can count exposures, control the quality and view images using the serial number of each plate in **Planmeca Romexis®** software.

Perfect for multi-room clinics

Planmeca ProScanner can be shared in the network between multiple treatment rooms. Shared use is based on RFID technology that automatically connects the patient file with the correct imaging plate. Prior exposure, the serial number of the plate is read in the treatment room with **Planmeca ProID™** RFID reader. Once the image has been scanned, it is automatically sent to the correct patient file and workstation.

New!



Planmeca Romexis® software for all images

Mac OS
and Windows
compatible



World leading imaging software



Planmeca Romexis® is an advanced, easy-to-use software suite providing a rich set of tools to meet the imaging requirements set by any dental facility – from a small clinic to a large hospital. It supports the most versatile range of 2D and 3D imaging modalities.



High-performance 2D imaging

Our advanced **Planmeca Romexis®** software suite offers the most versatile tools for 2D imaging. Diagnose images using our full range of enhancement tools – or view them wherever you are with our mobile apps. This flexible dental imaging suite adapts to your needs and will grow into the third dimension together with your practice.

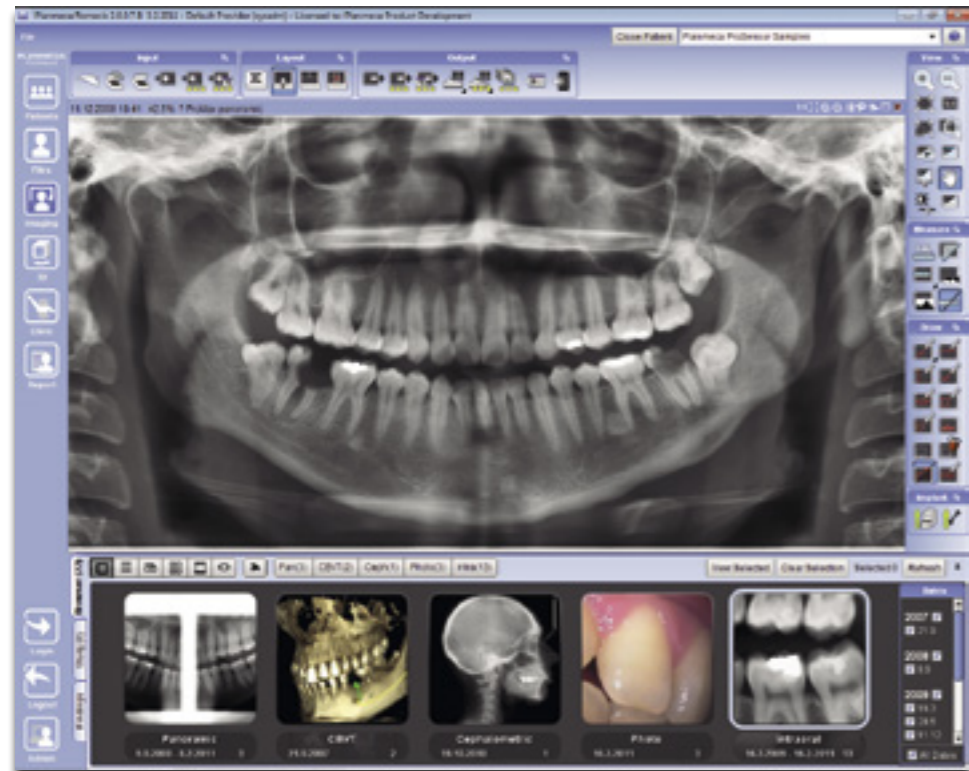

Easy and powerful

Planmeca Romexis® is the software of choice for viewing and processing 2D images from Planmeca X-ray units. Powerful enhancement and analysis tools guarantee that accurate diagnosis is available to users in all specialties, while the intuitive interface guarantees confident, comfortable use from day one.

Sharing the results

Cases can be seamlessly transferred to mobile devices or partner clinics that use Planmeca Romexis or the free **Planmeca Romexis® Viewer**. Our integration with other systems allows you to freely utilise third-party products at your clinic. TWAIN support and DICOM standard compliance ensure that the software can be used together with most systems.

Free Planmeca Romexis® Viewer application

Full-featured viewer application
No installation required
Mac OS and Windows support
Distribute to specialists or patients

Integrated document management

The printing module with multi-page support is ideal for creating professional, high-quality printouts and radiology reports to be sent to referring dentists.

Documents of any type can be attached to patient files, providing a convenient storage for cephalometric tracing reports, referral letters and other information.

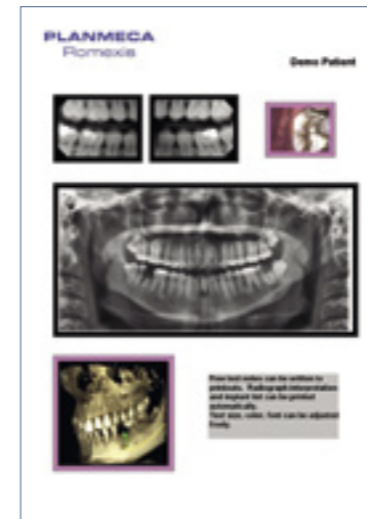

Advanced implant planning

Planmeca Romexis provides powerful tools for implant planning, including realistic implant models from over 30 manufacturers.

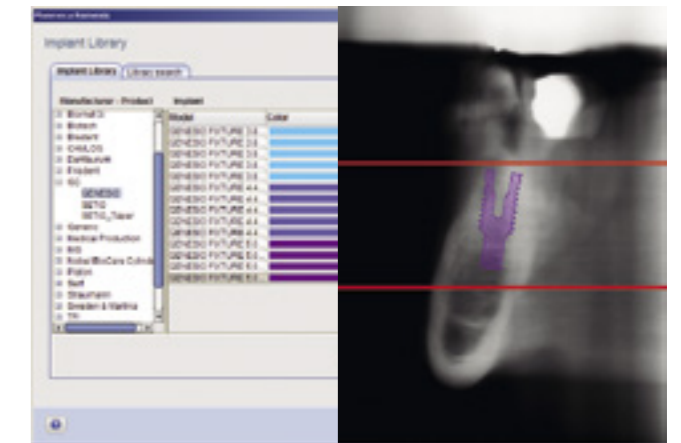

Radiology interpretation module

The **Planmeca Romexis® Radiological Findings** module is the most advanced findings-recording tool on the market. Developed in cooperation with clinicians, its findings list is hierarchically categorised and can be freely edited. The module is especially designed for educational and radiology centres where uniformity of recordings is essential.

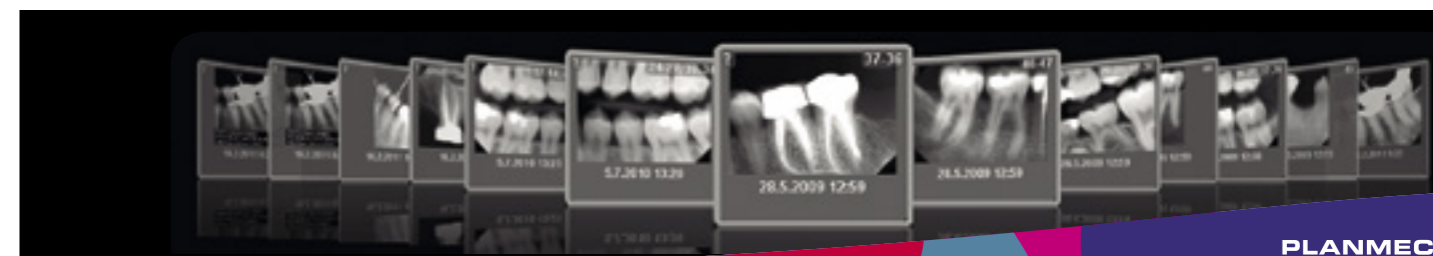
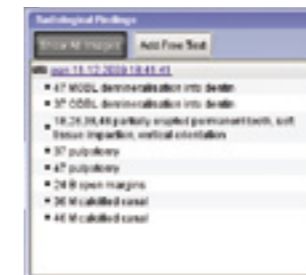

Your mobile world of imaging



Access your images from anywhere in the world with our advanced mobile application. Consult your colleagues and communicate with your patients easily – wherever you are.

Planmeca iRomexis™

Planmeca iRomexis™ is a mobile companion application for the **Planmeca Romexis®** imaging software. It is specially designed for iPhone and iPad to view 2D and 3D images, 3D models and **Planmeca ProFace®** images.

View all images taken with your Planmeca X-ray unit and communicate with your patients. Carry images on your mobile device – discuss with other professionals wherever you go. Experience a new level of freedom and co-operation with Planmeca iRomexis.

The application can be downloaded from the App Store free of charge.



Planmeca iRomexis™

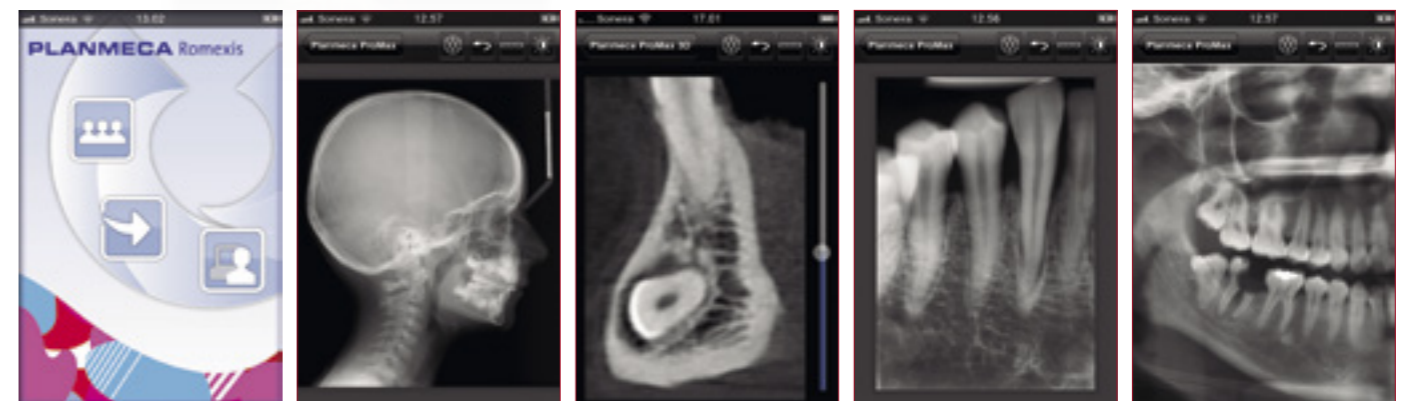
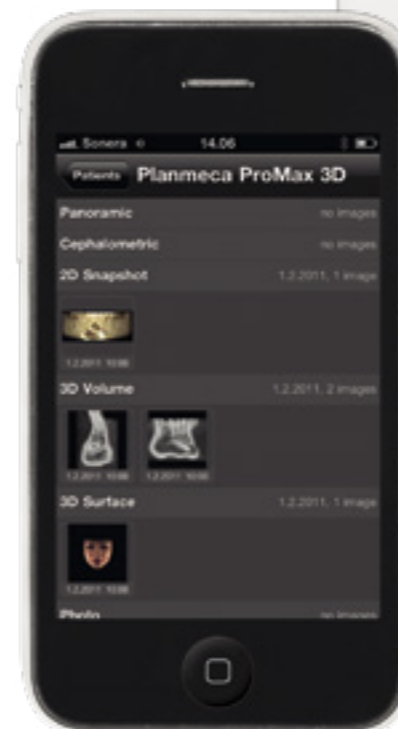

Share images and expertise online

Planmeca Romexis® Cloud is an advanced image transfer service exclusive to Planmeca Romexis® users. Now you can share images and expertise securely with all partners who use Planmeca Romexis, the free Planmeca Romexis® Viewer or the Planmeca iRomexis™ mobile application.



Planmeca Romexis® user

- Radiology center
- General practice

Planmeca Romexis® Cloud

**IMAGE
REFERRAL
INTERPRETATION**

Anybody, anywhere

- General practitioner
- Colleague
- Radiologist
- Specialist
- Dental lab
- Patient

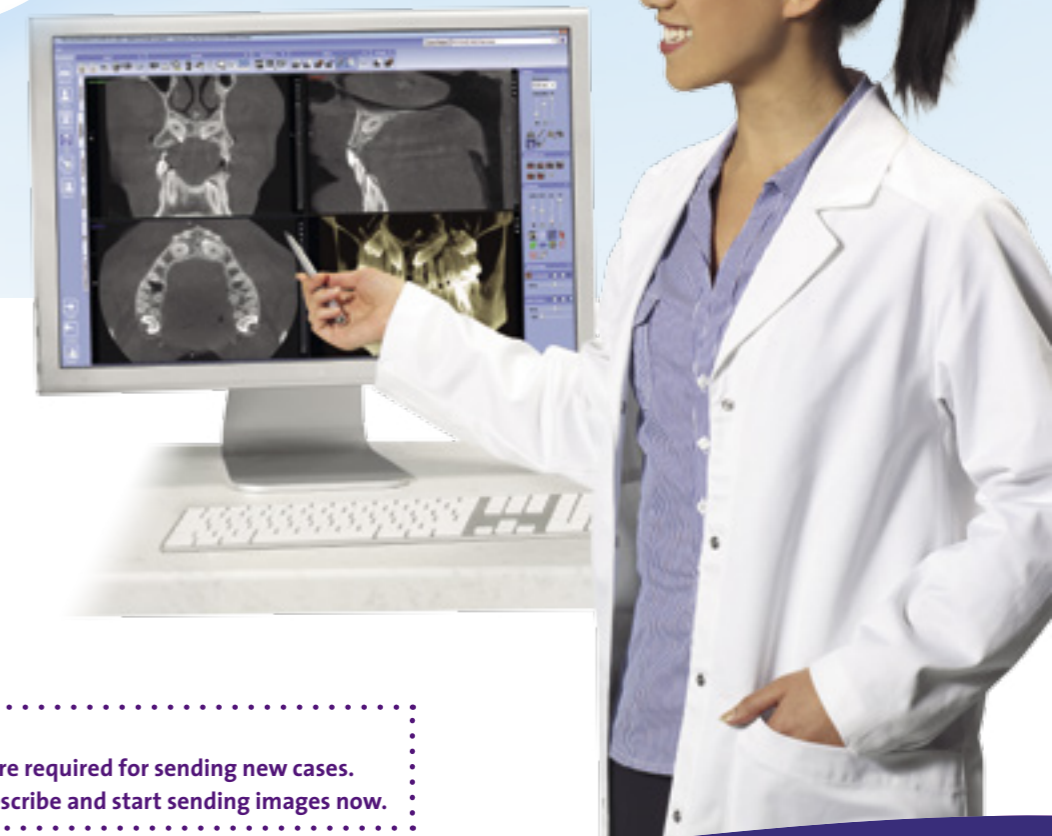

Advantages

- Seamlessly integrated into **Planmeca Romexis®** ensuring an efficient workflow – no need for external applications or CDs and DVDs
- Automatic delivery of images and attachments
- Automatic notification to recipient of new cases

- Cases can be sent to any recipient who has an e-mail account
- Secure transfer and storage of information
- Streamline your communication with **Planmeca Romexis® Cloud**

Features

Sending images to recipient

- 2D images: panoramic, cephalometric, photos, intraoral X-ray images
- 3D images: CBCT, 3D photos, surface scans
- All annotations and other elements are included

Sending documents to recipient

- Attach one or more referrals, reports, or other documents

Versatile possibilities for communication

Recipients can download and view images at no cost using:

- Planmeca Romexis
- Free **Planmeca® Romexis Viewer**
- Free **Planmeca iRomexis™** iOS application on iPad and iPhone

Planmeca Romexis® software and Planmeca Romexis® Cloud subscription are required for sending new cases. Visit <http://online.planmeca.com/> to subscribe and start sending images now.

Technical specifications

Dimensions for unit with film-based cephalostat

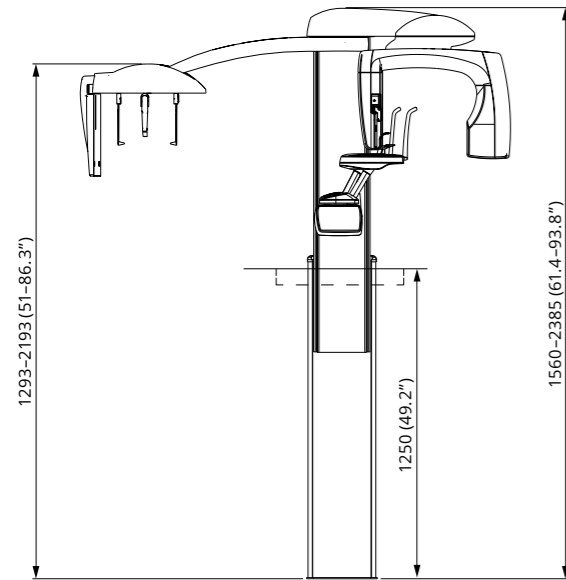

Dimensions for unit with digital cephalostat

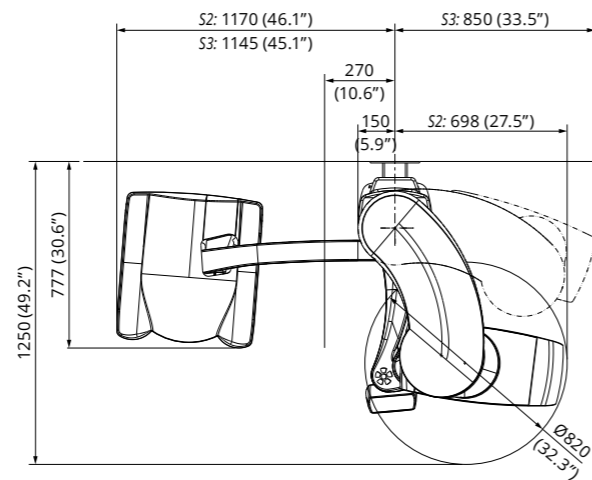
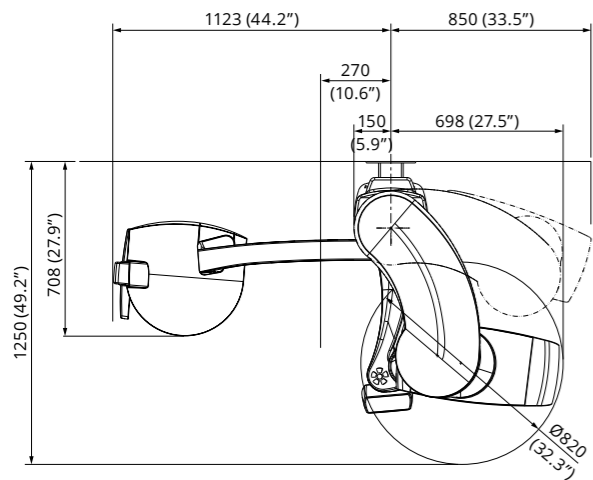
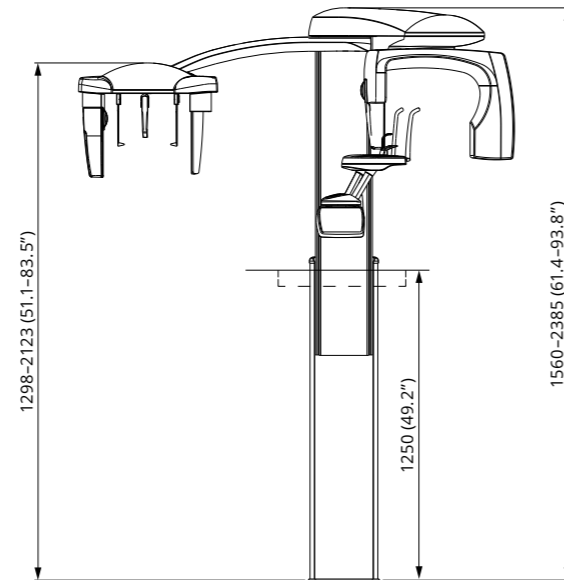

Physical space requirements

	Planmeca ProMax 2D	Planmeca ProMax 2D with cephalostat
Width	96 cm (38 in.)	194 cm (76 in.)
Depth	125 cm (49 in.)	125 cm (49 in.)
Height*	153-243 cm (60-96 in.)	153-243 cm (60-96 in.)
Weight	113 kg (lbs 248)	128 kg (lbs 282)

Minimum operational space requirements

	Planmeca ProMax 2D	Planmeca ProMax 2D with cephalostat
Width	150 cm (59 in.)	215 cm (85 in.)
Depth	163 cm (64 in.)	163 cm (64 in.)
Height*	243 cm (96 in.)	243 cm (96 in.)

*The maximum height of the unit can be adjusted for offices with limited ceiling space.

Technical data

Generator	Constant potential, resonance mode high frequency 80-150 kHz	
X-ray tube	D-054SB-P	
Focal spot size	0.5 x 0.5 mm (IEC 336)	
Total filtration	min. 2.5 mm Al equivalent	
Anode voltage	50-84 kV	
Anode current	0.5-16 mA DC	
Exposure time	Pan	2.7-16 s
	Ceph	0.2-19 s
	Tomo	3-24 s / frame
SID	Pan	500 mm (19 in.)
	Ceph	163-170 cm (64-67 in.)
Magnification	Pan	constant 1.2
	Ceph	1.08-1.13
CCD pixel size	48 µm	
Image pixel size	48/96/144 µm selectable	
CCD active surface	Pan	6 x 147 mm
	Ceph	6 x 295 mm
Resolution (digital)	Pan	max. 9 lp/mm
	Ceph	max. 5.7 lp/mm
Image field (digital)	Pan	14 x 30 cm (5.5 x 12 in.)
	Ceph	24/27 x 18/30 cm (9/10.6 x 7/11.8 in.)
File size, uncompressed (digital)	Pan	4-33 MB
	Ceph	7-16 MB
Line voltage	100-240 V, 50 or 60 Hz	
Regulation	Automatic, ±10 %	
Line current	8-16 A	
Colour	White (RAL 9016)	

Imaging programs

	Planmeca ProMax 2D S3	Planmeca ProMax 2D S2
<i>Standard:</i> Basic panoramic programs	Standard panoramic Lateral TMJ (closed & open) PA TMJ (closed & open) PA sinus	Standard panoramic Lateral TMJ (closed & open) PA TMJ (closed & open) PA sinus
<i>Standard</i>	Child (Paediatric) mode for each standard and optional program to reduce the dose	
<i>Optional</i>	Horizontal and vertical segmenting for panoramic program	Horizontal and vertical segmenting for panoramic program
<i>Optional</i>	True Bitewing	Bitewing
<i>Optional:</i> Advanced panoramic programs	Interproximal panoramic Orthogonal (perio) panoramic Lateral-PA TMJ Lateral multiangle TMJ PA multiangle TMJ PA linear sinus Lateral sinus	
<i>Optional:</i> Tomography programs	Digital linear tomography and Transtomography in digital unit True linear tomography or Linear tomography in film unit	

Stand out with colour

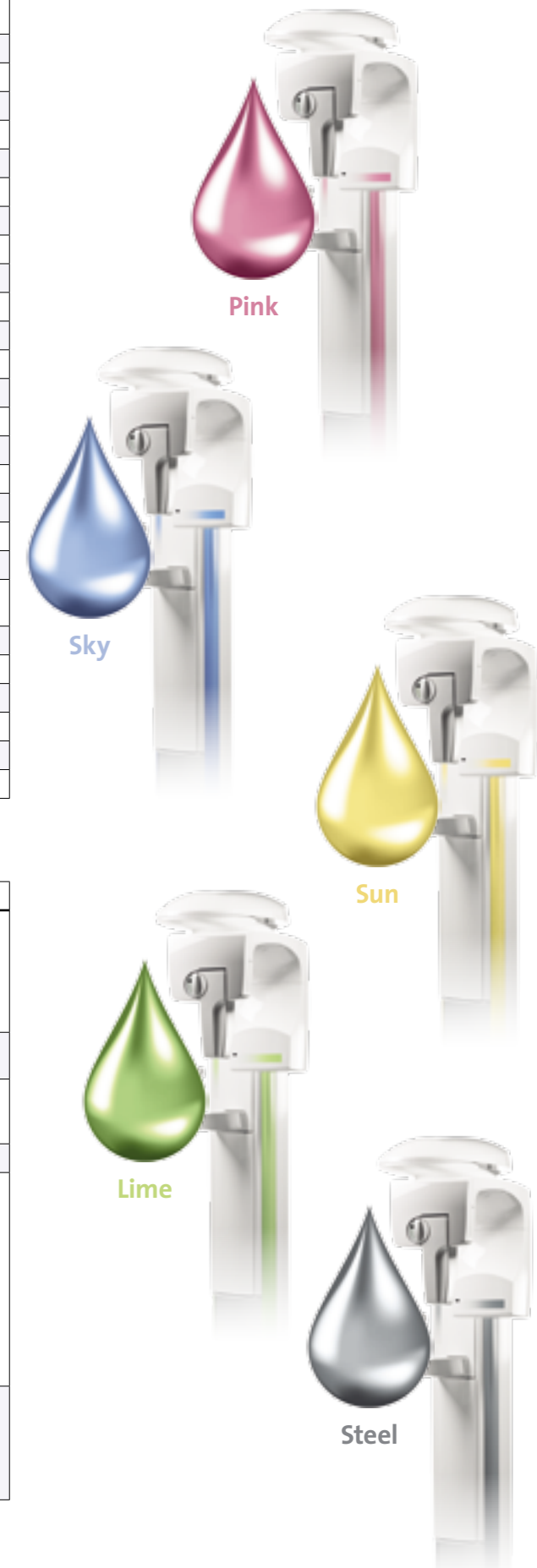

Technical specifications

Technical data

Generator	Constant potential, resonance mode high frequency 60–80 kHz
X-ray tube	D-058SBR
Focal spot size	0.5 x 0.5 mm (IEC 336)
SID	480 mm (19 in.)
Total filtration	min. 2.5 mm Al eq.
Anode voltage	60–70 kV
Anode current	2–7 mA DC
Exposure time	2–10 s
Magnification	1.22–1.29
Line voltage	100–132 V~ 50/60 Hz, 180–240 V~ 50 Hz
Regulation	±10 % (automatic)
Line current	8–16 A
Power uptake	max: 850 W
Chin rest level	95–178 cm (37.4–70 in.)
Colour	White (RAL 9016)
Weight	67 kg (148 lbs)

Dimensions

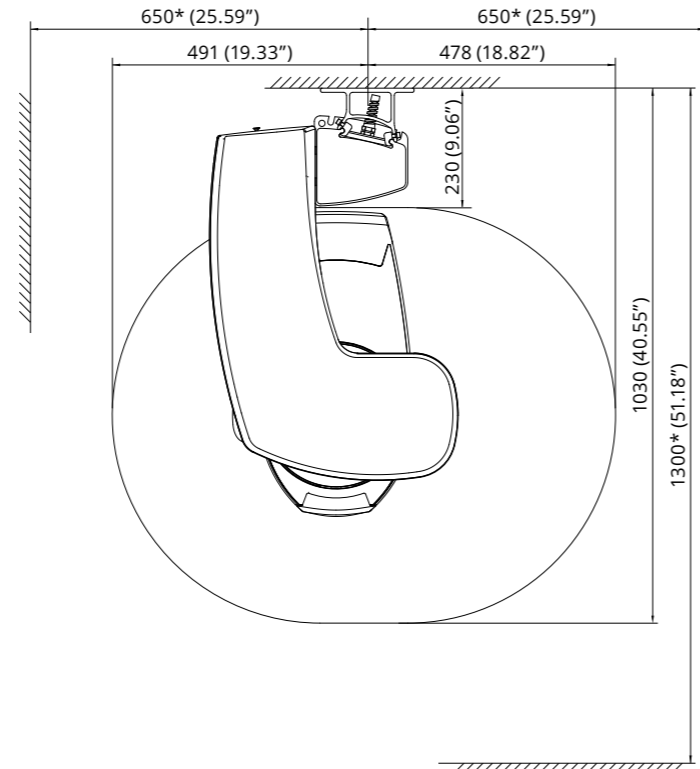

Imaging programs

Basic panoramic programs	Standard panoramic
	Lateral TMJ
	PA TMJ
Advanced panoramic programs	PA Sinus
	Horizontal and vertical segmenting for panoramic program
	Bitewing
	Interproximal panoramic
	Orthogonal (perio) panoramic
	Lateral-PA TMJ
	Lateral multiangle TMJ
	Lateral non rotational sinus
	Cross-sections
	Child (Paediatric) mode for each program to reduce the dose

*Minimum operational space requirements

Width	Depth	Height
130 cm	130 cm	223 cm
51 in.	51 in.	88 in.

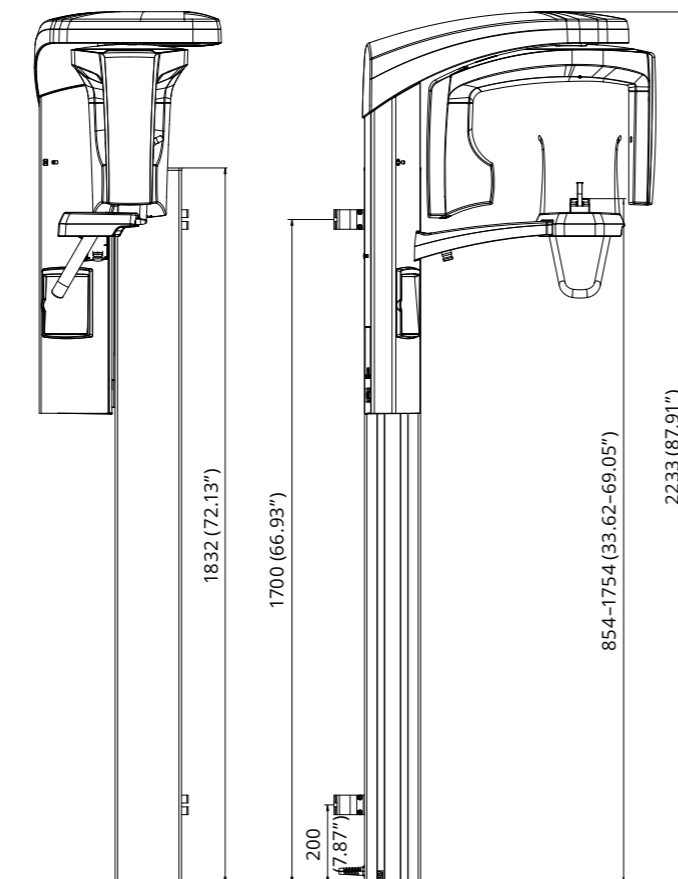

Technical specifications

Technical data

Generator	Constant potential, microprocessor controlled, operating frequency 66 kHz
X-ray tube	Toshiba D-041SB
Focal spot size	0.4 mm according to IEC 60336
Cone diameter	60 mm (2.36 in.) Rectangular 33 x 43 mm (1.30 x 1.69 in.)
Max. symmetrical radiation field	Ø60 mm at SSD 200 mm Ø60 mm at SSD 300 mm according to IEC 806
Total filtration	min. 2.5 mm Al equivalent at 70 kV according to IEC 60522
Inherent filtration	1 mm Al equivalent at 70 kV according to IEC 60522
Anode voltage	8 mA: 50, 52 kV, ±2 kV 7 mA: 50, 52, 55, 57, 60 kV, ±2 kV 2–6 mA: 50, 52, 55, 57, 60, 63, 66, 70 kV, ±2 kV
Anode current	8, 7, 6, 5, 4, 3, 2 mA ±(5% + 0.2 mA)
Exposure times	0.01–2 sec. ±(5% + 0.001 sec.), 24 steps
SSD (Source-Skin Distance) Standard/Long	200 mm (8 in.)/300 mm (12 in.)
Mains voltage	100 V~/110–115 V~/220–240 V~, 50/60 Hz
Duty cycle	1:30, automatic control
Electrical classification	Class I Type B
Weight	total 29 kg (64 lbs) tube head with standard cone 4.2 kg (9.3 lbs) tube head with long cone 4.5 kg (10 lbs)
Colour	White (RAL 9016)

Dimensions

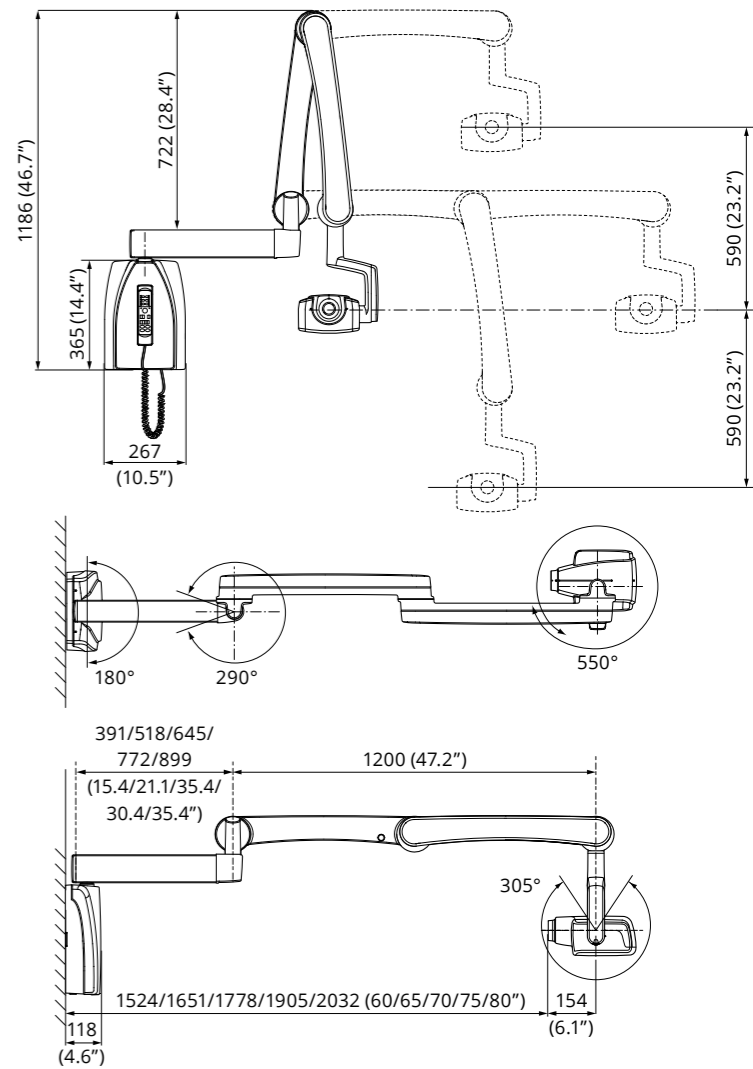

Installation options

Standard wall mount 	Remote control panel 	Fixed control panel with double exposure button 	Dental unit mount
Ceiling mount 	Mobile stand 	Single stud mount 	

Technical specifications

Technical data for Planmeca ProSensor®

	Size 0	Size 1	Size 2
Sensor size	33.6 x 23.4 mm (1.33 x 0.92 in.)	39.7 x 25.1 mm (1.56 x 0.99 in.)	44.1 x 30.4 mm (1.76 x 1.2 in.)
Active area	25.5 x 18.9 mm (1.0 x 0.74 in.)	31.5 x 20.7 mm (1.24 x 0.81 in.)	36 x 26.1 mm (1.42 x 1.03 in.)
Number of pixels	850 x 629 px	1050 x 690 px	1200 x 870 px
Physical pixel size	15 µm x 15 µm		
Pixel size	30 µm x 30 µm		
Theoretical resolution	33 lp/mm		
Resolution	17 lp/mm		
Interface	USB or Ethernet		
View delay	<5 sec.		



Technical data for Planmeca ProScanner™

	0	1	2	3	4c
Imaging plate size	22 x 31 mm (0.87 x 1.22 in.)	24 x 40 mm (0.94 x 1.57 in.)	31 x 41 mm (1.22 x 1.61 in.)	27 x 54 mm (1.06 x 2.13 in.)	48 x 54 mm (1.89 x 2.13 in.)
Pixel Matrix, Standard	343 x 484 px	375 x 625 px	484 x 640 px	421 x 843 px	750 x 843 px
Pixel Matrix, High	628 x 885 px	685 x 1143 px	886 x 1171 px	771 x 1542 px	1370 x 1542 px
Selectable pixel size, Standard	64 µm				
Selectable pixel size, High	35 µm				
Readout time	4.1 – 7.2 sec				
Resolution	Data Capture: 16-bits per pixel, 65 000 greytone				
Eraser	Embedded				
Dimensions (H x W x D)	265 x 120 x 318 mm (10.4 x 4.7 x 12.5 in.)				
Weight	5.5 kg (12.1 lbs)				
System configuration	Tabletop				
Interface	USB 2.0 high speed (480 Mbps) / Ethernet (100 Mbps)				

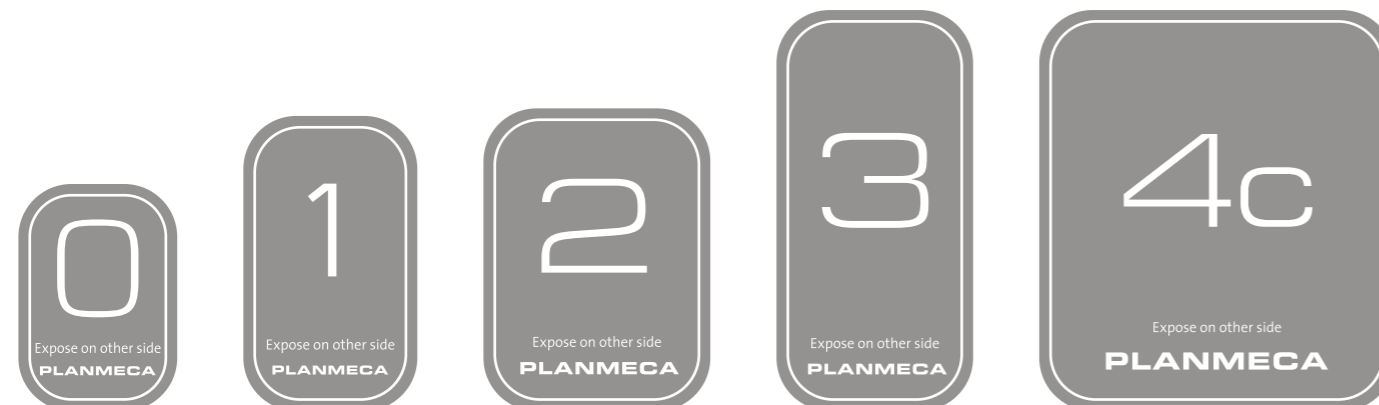

Technical specifications

Supported 2D modalities	Intraoral Panoramic Cephalometric 2D linear tomography Photos Stack images (CBCT slices and panoramic slices)
Supported 3D modalities	3D CBCT 3D photo 3D surface scan
Supported photo sources	Intraoral camera Digital camera or scanner (import or TWAIN capture)
Operating systems	Win XP / Win Vista Pro/ Win 7/ Win 8 Win 2003 Server /Win 2008 Server Mac OS X* For detailed information please see system requirements of Planmeca Romexis www.planmeca.com *Cephalometric Analysis module and 3D Ortho Studio module are not supported on Mac OS.
Image formats	JPEG or TIFF (2D image) DICOM (2D and 3D image) STL (3D image) TIFF, JPEG, PNG, BMP (import/export)
Image size	2D X-ray image: 1-9 MB 3D X-ray image: typically 50 MB-1 GB
Installation options	Client-Server Java Web Start deployment
DICOM 3.0 support	DICOM Import/Export DICOM DIR Media Storage DICOM Print SCU DICOM Storage SCU DICOM Worklist SCU DICOM Query/Retrieve DICOM Storage Commitment DICOM MPPS
Interfaces	TWAIN Client PMBridge (patient information and images) VDDS (patient information and images) InfoCarrier (patient information) Datagate (patient and user information)
3 rd party software integrations	Dolphin Imaging Nobel Clinician Materialise Dental Simplant Straumann coDiagnostiX Cybermed N-Liten





Planmeca Oy designs and manufactures a full line of high technology dental equipment, including dental care units, panoramic and intraoral X-ray units, and digital imaging products. Planmeca Oy, the parent company of the Finnish Planmeca Group, is strongly committed to R&D, and is the largest privately held company in the field.

PLANMECA

Asentajankatu 6 | 00880 Helsinki | Finland | tel. +358 20 7795 500 | fax +358 20 7795 555 | sales@planmeca.com | www.planmeca.com

Images may contain optional items not included in standard delivery. Available configurations and features may have country or area specific variations. Some products displayed above may not be available in all countries or areas. Rights for changes reserved.

Planmeca, All in one, Anatomat Plus, Cobra, Comfy, DentoVac, Digital perfection, Economat Plus, Elegant, Flexy, Perio Fresh, PlanEasyMill, Planmeca AINO, Planmeca ARA, Planmeca Chair, Planmeca Compact, Planmeca Intra, Planmeca iRomexis, Planmeca Lumion, Planmeca Minea, Planmeca Minendo, Planmeca Minetto, Planmeca Noma, Planmeca Online, Planmeca PlanCAD, Planmeca PlanMill, Planmeca PlanScan, Planmeca Planosil, Planmeca ProCeph, Planmeca ProFace, Planmeca ProID, Planmeca ProMax, Planmeca ProModel, Planmeca ProOne, Planmeca ProScanner, Planmeca ProSensor, Planmeca ProX, Planmeca Romexis, Planmeca SingLED, Planmeca Sovereign, Planmeca Vision, Planmeca Waterline Cleaning System, Proline Dental Stool, ProTouch, Saddle Stool, SmartPan, SmartTouch, Trendy and UltraTouch are registered or non-registered trademarks of Planmeca in various countries.

10032800/0414/en

